

- STRAIGHT TRACK SERIES
- BENDABLE & STRAIGHT TRACK SERIES
- CURVED TRACK SERIES
- SILENT TRACK SERIES
- DOUBLE TRACK SERIES
- EMBEDDED TRACK SERIES
- THREE IN ONE CURTAIN BOX SERIES



FOSHAN YIKAIXUAN HOUSEHOLD PRODUCTS CO.,LTD.

Xia'an Industrial Zone,Danzao Town,Nanhai District,Foshan City,Guangdong Province,China



CURTAIN TRACK CATALOG



Our factory possess an area of 15,000 square meters, over 120 employees and more than 10 automatic production equipments.

ABOUT US



FOSHAN YIKAIXUAN HOUSEHOLD PRODUCTS CO.,LTD. was founded in 2003. Our factory is located in Foshan City, China, Factory covers an area of 15,000 square meters, have more than 200 workers. YIKAIXUAN company, a set of materials processing, product development, production, marketing as one of the integrated production enterprises.

- More than 20 years' industry experience in aluminum curtain rods, tracks, and aluminum field
- We have obtained the quality management system of ISO9001
- We have obtained more than 80 patents
- OEM & ODM are all acceptable



The factory have many years of aluminium extrusion production experience, own several aluminium extrusion lines, anodized line, powder coating line. The major products are aluminium profiles for curtain tracks and rails, Aluminum profiles for window decoration and shading.



At the same time, the factory also produce the finished aluminium curtain track and curtain rails in set. YIKAIXUAN has a number of patents, with a strong R & D ability, can provide customized services for customers.

FACTORY

THE SPIRIT OF ORIGINALITY

The enterprise has obtained ISO9001 quality management system certification; Value of Enterprise is learning, innovation, unity, and advance: Vision is to create the most influential international decorative window decoration brand.

ENTERPRISE HONOR



UTILITY MODEL PATENT

INDUSTRIAL DESIGN PATENT

INDUSTRIAL DESIGN PATENT

GB/T19001-2016/ISO9001:2015



The mission of the enterprise is to benefit all beings and find a way out for employees! Dare to bear, to make contributions to the society! The enterprise takes the market demand as the guidance, takes the scientific management as the means, fully develops and the reasonable utilization resources, continuously improves, and satisfies the domestic and foreign customer demand with the high quality product, Perfect facilities to meet the needs of internal and foreign customers. Welcome new and old friends presence, guidance Visit and business negotiations.



HIGH&NEW TECHNOLOGY ENTERPRISE CERTIFICATE



TABLE OF CONTENT

After 20 years, from scratch, do not forget the original heart, dialogue with customers with products, service to win the market, determined to create a leading brand in the window decoration industry

| | |
|---------------------------------------|---------|
| 01 STRAIGHT TRACK SERIES | 1-58 |
| 02 BENDABLE & STRAIGHT TRACK SERIES | 59-64 |
| 03 CURVED TRACK SERIES | 65-92 |
| 04 SILENT TRACK SERIES | 93-112 |
| 05 DOUBLE TRACK SERIES | 113-120 |
| 06 EMBEDDED TRACK SERIES | 121-126 |
| 07 THREE IN ONE CURTAIN BOX SERIES | 127-128 |
| 08 OTHERS | |

01 STRAIGHT TRACK SERIES



HOT SALE
 B50
 —
 TEXTURE IS EXCELLENT
 HIGH QUALITY
 —
 THICK ALUMINUM



MUTE STRIP
 MATTE TEXTURE
 —
 ANTI-CORRSION
 ANTI-RUST
 LONG-LASTING
 —
 HUMANIZATION DESIGN

HOT SALE



CS53



B50



B86



CS51



WR152



WR331



WR372

B50



ZF-25
PARAMETER

LENGTH: 6.7/6.0M/PCS
WEIGHT: 0.227KG/M

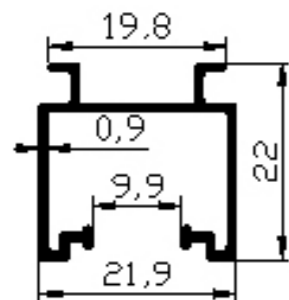

B86

○ Electrophoretic porcelain white

● Porcelain swimming light gray

● Curry Blue



BEAUTIFUL W-2 NANO SQUARE TRACK
PARAMETER

LENGTH: 6.7/6.0M/PCS
WEIGHT: 0.23KG/M
THICKNESS: 1.0MM

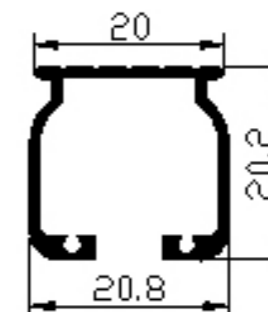

CS51

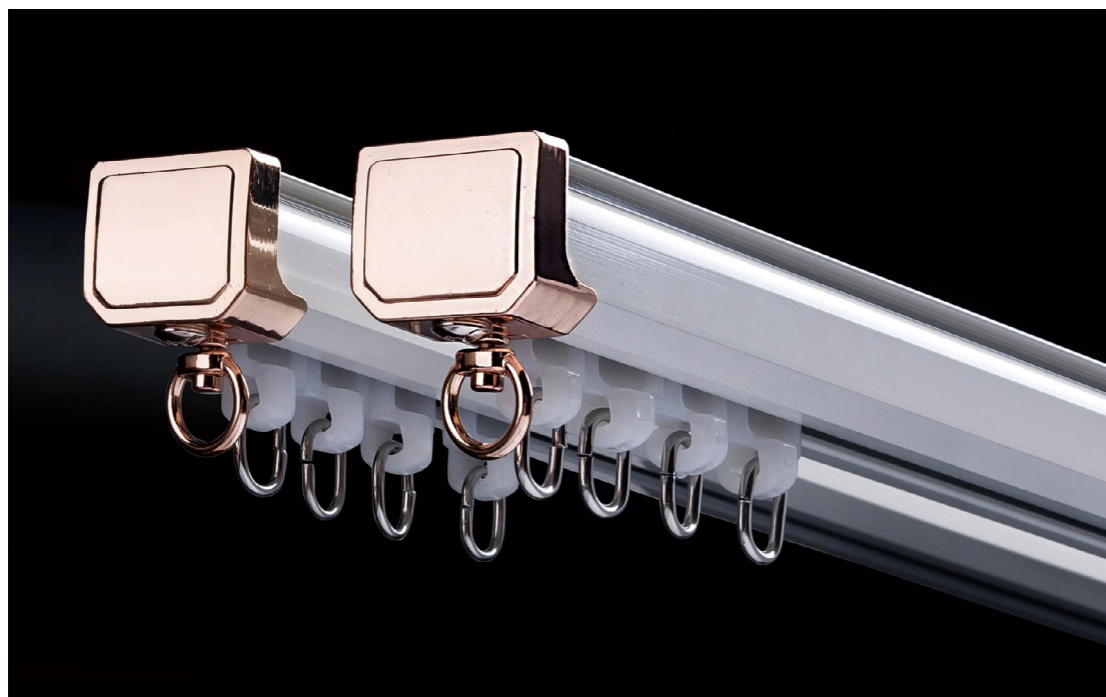

EXTRA THICK LARGE SQUARE TRACK B-TYPE

PARAMETER

LENGTH: 6.7/6.0M/PCS

WEIGHT: 0.266KG/M

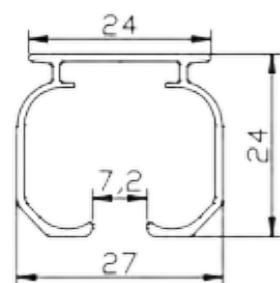

CS53



HEAVY DUTY LARGE SQUARE TRACK C-TYPE

PARAMETER

LENGTH: 6.7/6.0M/PCS

WEIGHT: 0.297KG/M

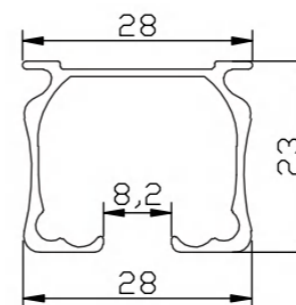

WR152



ECONOMIC NANO LARGE SQUARE TRACK

LENGTH: 6.7/6.0M/PCS

WEIGHT: 0.128KG/M

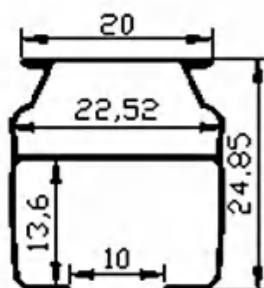

WR331



NANO SQUARE TRACK PARAMETER

LENGTH: 6.7/6.0M/PIECE

WEIGHT: 0.297KG/M

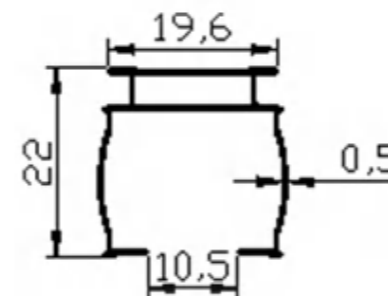

WR372



NANO SMALL SQUARE TRACK

PARAMETER

LENGTH: 6.7/6.0M/PCS

WEIGHT: 0.107KG/M

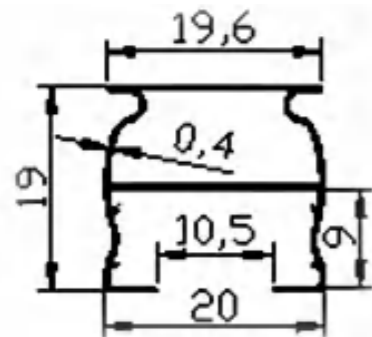

INVENTORY
WR210
—
TEXTURE IS EXCELLENT
HIGH QUALITY
—
THICK ALUMINUM



ANTI-CORRSION
ANTI-RUST
LONG-LASTING
—
HUMANIZATION DESIGN



IN STOCK >>>

IN STOCK



IF YOU WANT MORE STYLES, PLEASE CONSULT CUSTOMER SERVICE

B01

- Electrophoretic ivory white
- Crystal swim champagne

CLASSIC GENEROUS TRACK SERIES

PARAMETER

LENGTH: 6.7/6.0M/PIECE

WEIGHT: 0.326KG/M

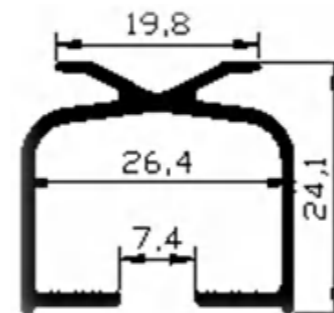

B34

We have stable raw material purchasing line, we keep the superior grandraw material to keep high quality.

U-SHAPED MEDIUM
SQUARE TRACK

PARAMETER

—
LENGTH: 6.7/6.0M/PIECE
WEIGHT: 0.232KG/M

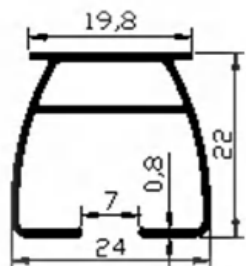

B35

For more colors and details of the product,
please consult customer service

U-SHAPED SMALL
SQUARE TRACK

PARAMETER

—
LENGTH: 6.7/6.0M/PIECE
WEIGHT: 0.155KG/M

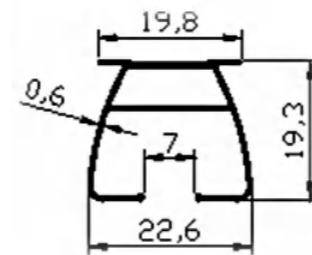

B59

○ B59-01 Ivory white



● B59-02 Apple Gold

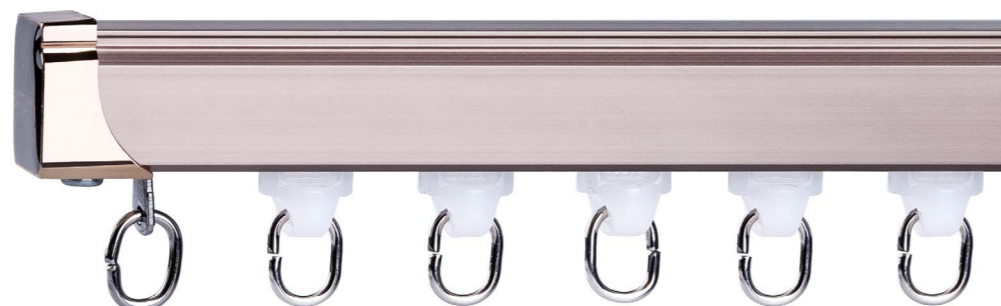

YILA NANO SQUARE TRACK

PARAMETER

LENGTH: 6.7/6.0M/PIECE

WEIGHT: 0.199KG/M

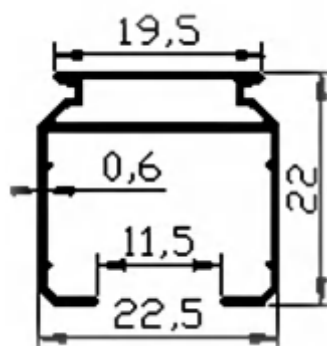

B63

○ B63-01 Electrophoretic Ivory



● B63-02 Matte apple gold

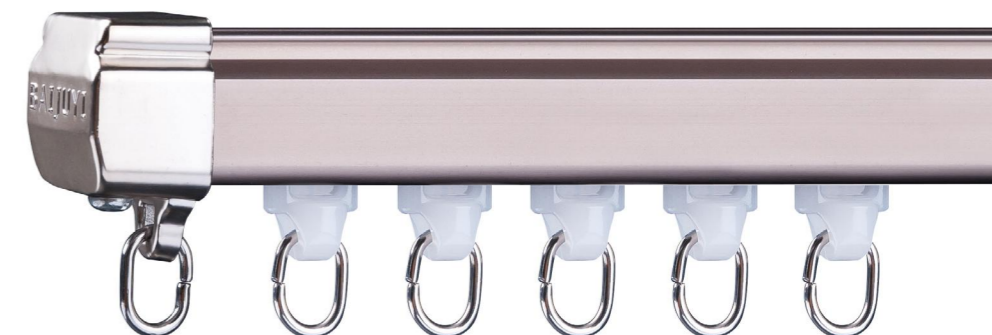

ROLA MEDIUM SQUARE TRACK

PARAMETER

LENGTH: 6.7/6.0M/PIECE

WEIGHT: 0.233KG/M

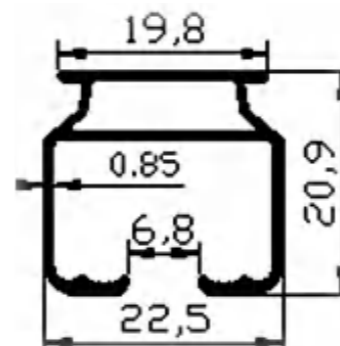

B85

○ Electrophoretic porcelain white

● Porcelain swimming light gray

● Curry Blue

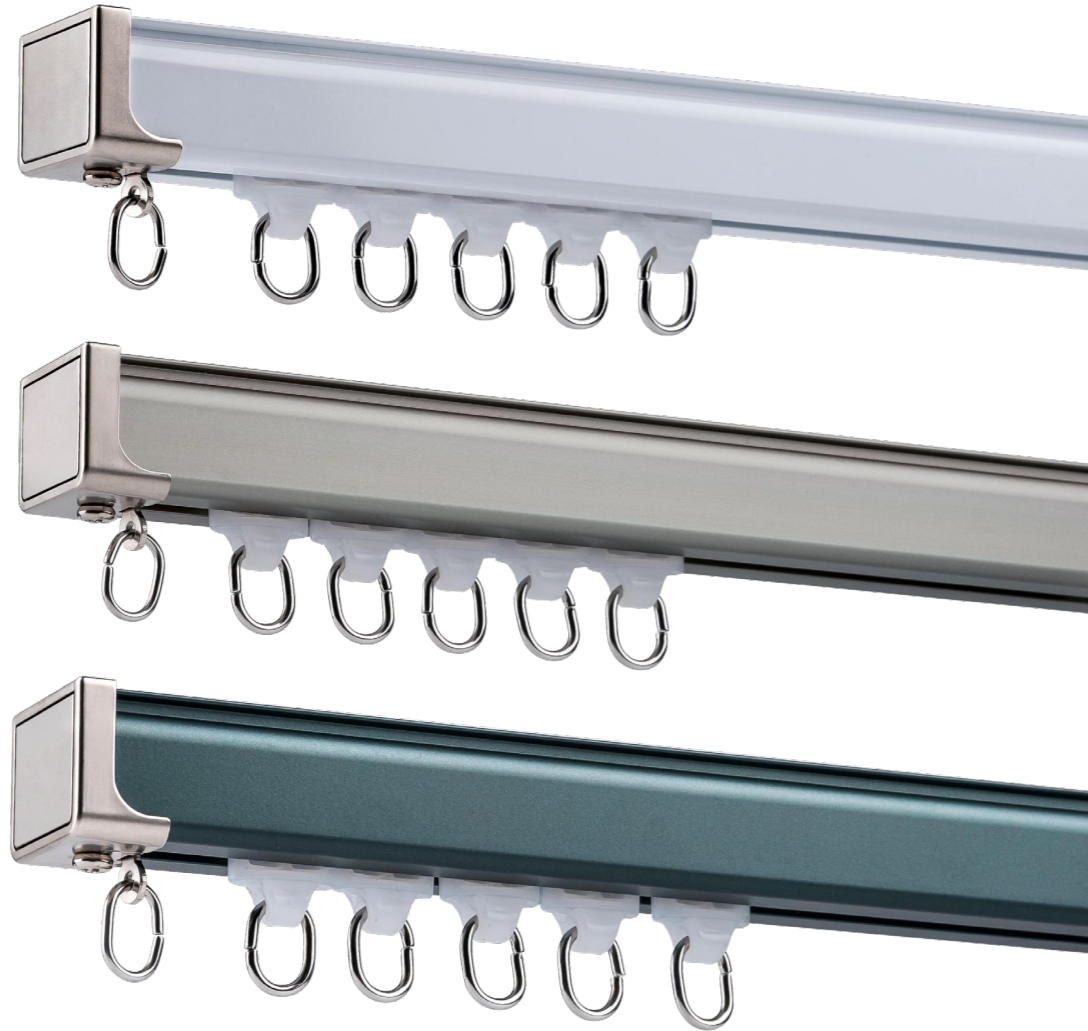

BEAUTIFUL W-1 NANO LARGE SQUARE TRACK
PARAMETER

—
LENGTH: 6.7/6.0M/PCS

WEIGHT: 0.371KG/M

THICKNESS: 1.1MM

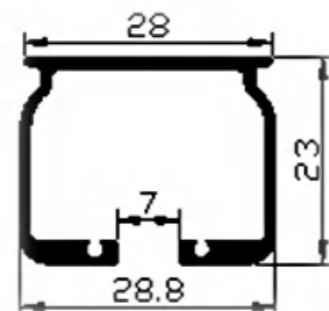

B88

○ Sand white

● Sand black

● Sand blue

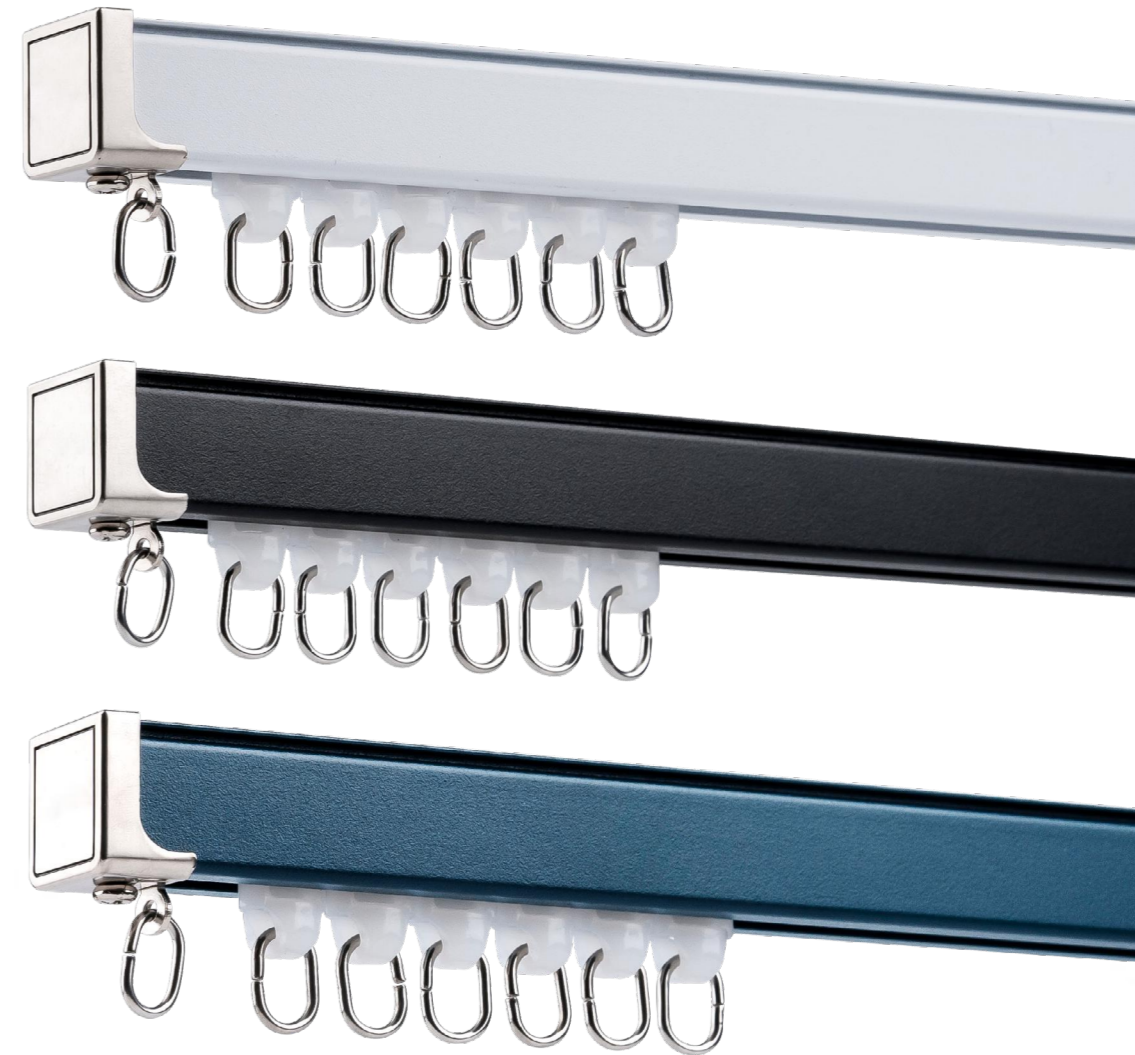

MODERN MINIMALIST F-1 NANO SQUARE TRACK
PARAMETER

—
LENGTH: 6.7/6.0M/PCS

WEIGHT: 0.214KG/M

THICKNESS: 0.6MM

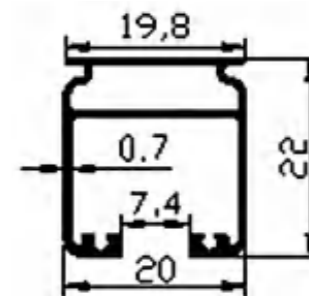

CS21



THREE WIRE NANO C-TYPE

PARAMETER

LENGTH: 6.7/6.0M/PCS

WEIGHT: 0.116KG/M

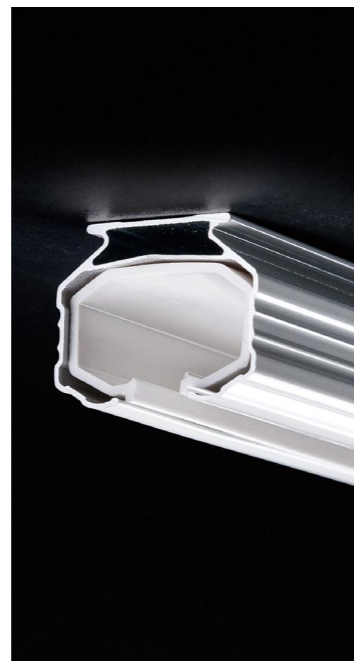
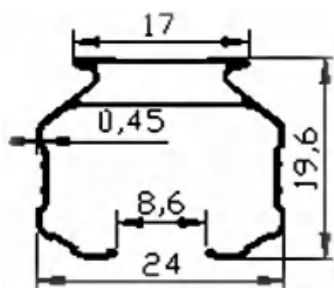

CS95

For more colors and details of the product, please consult customer service



PARAMETER

LENGTH: 6.7/6.0M/PIECE

WEIGHT: 0.112KG/M

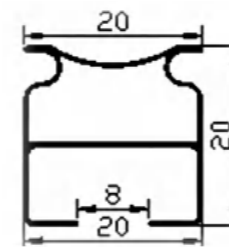

CS185



THICKENED TIMES OF MEDIUM SQUARE CURTAIN TRACK

LENGTH: 6.7/6.0M/PCS

WEIGHT: 0.429KG/M

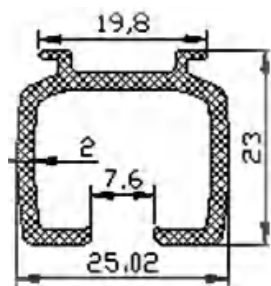

CS186



THICKENED TIMES OF SMALL SQUARE TRACK

LENGTH: 6.7/6.0M/PIECE

WEIGHT: 0.368KG/M

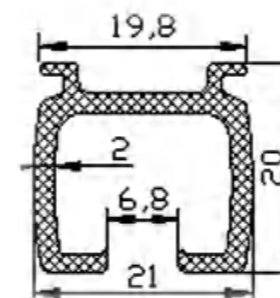

M45



NEW ERA MEDIUM SQUARE TRACK SERIES

OXIDATION/ELECTROPHORESIS

LENGTH: 6.7/6.0M/PCS

WEIGHT: 0.285KG/M

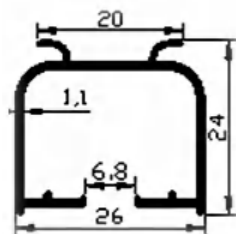

M54



THREE LINE LARGE MEDIUM SQUARE TRACK

ELECTROPHORESIS

LENGTH: 6.7/6.0M/PIECE

WEIGHT: 0.421KG/M

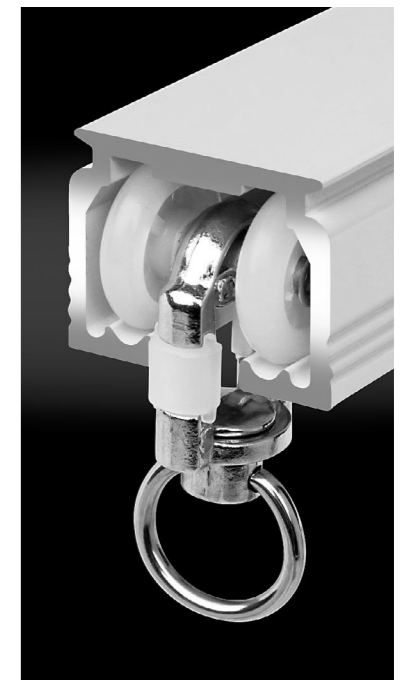
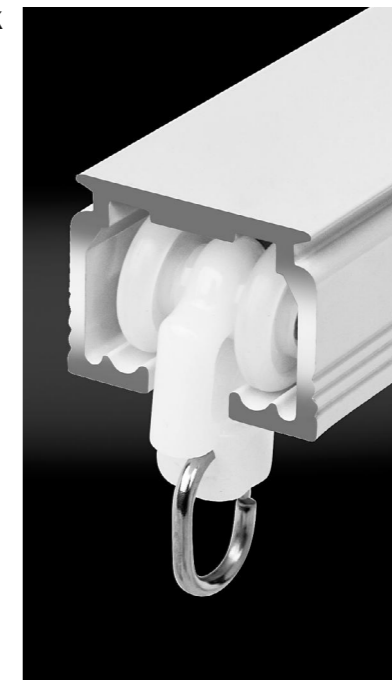
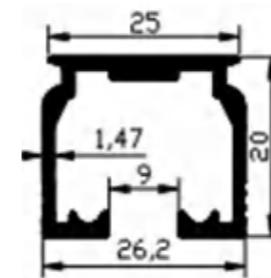

M89



LIGHT LUXURY D+6 SMALL SQUARE TRACK

PARAMETER

—
 LENGTH: 6.7/6.0M/PCS
 WEIGHT: 0.228KG/M
 THICKNESS: 0.9MM

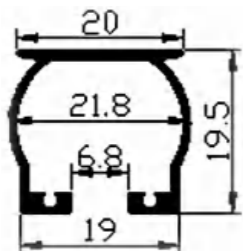

WR210



ALTAI T9 NANO MEDIUM SQUARE TRACK

PARAMETER

—
 LENGTH: 6.7/6.0M/PCS
 WEIGHT: 0.147KG/M
 THICKNESS: 0.9MM

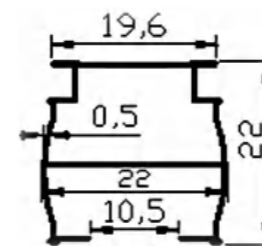

WR334

22+16 nm small square track

If you want to know more about the size, color and details, please consult customer service.



22+16 NM SMALL SQUARE TRACK

PARAMETER

LENGTH: 6.7/6.0M/PIECE

WEIGHT: 0.113KG/M

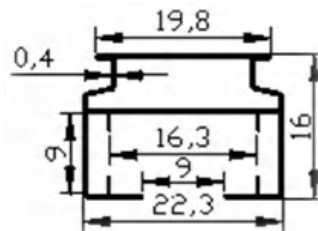

CUSTOMIZATION



B22

○ B22-02 Electrophoresis ivory white

● B22-03 Matte Apple gold



FASHION MEDIUM SQUARE TRACK

PARAMETER

LENGTH: 6.7/6.0M/PIECE

WEIGHT: 0.195KG/M

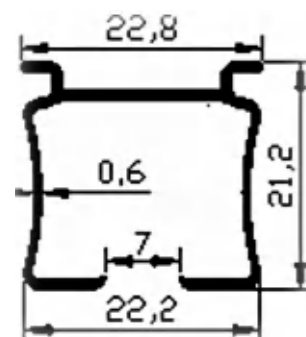

B29

● B29-01 Electrophoretic Champagne

○ B29-02 Ivory white



THREE WIRE NANO SQUARE TRACK

PARAMETER

LENGTH: 6.7/6.0M/PIECE

WEIGHT: 0.173KG/M

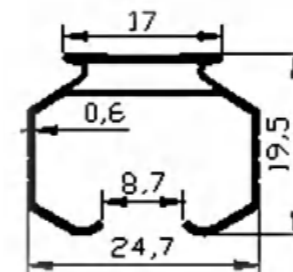

B89

○ Sand white



● Sand blue



● Sand black



MODERN MINIMALIST F-2 NANO
MEDIUM SQUARE TRACK

—
LENGTH: 6.7/6.0M/PCS
WEIGHT: 0.194KG/M
THICKNESS: 0.7MM

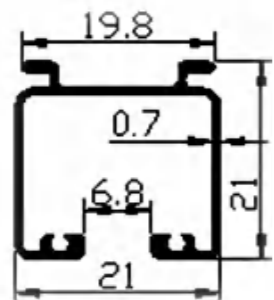

B90

○ Sand white



● Sand blue



● Sand black



MODERN MINIMALIST F-2 NANO
MEDIUM SQUARE TRACK

—
LENGTH: 6.7/6.0M/PCS
WEIGHT: 0.288KG/M
THICKNESS: 1.2MM

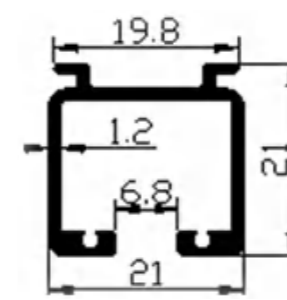

CS22



THREE WIRE NANO MEDIUM SQUARE

TRACK B-TYPE

LENGTH: 6.7/6.0M/PCS

WEIGHT: 0.147KG/M

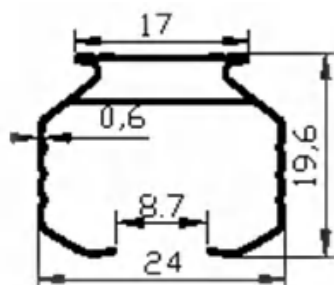

CS23



THREE WIRE NANO MEDIUM SQUARE

TRACK A-TYPE

LENGTH: 6.7/6.0M/PIECE

WEIGHT: 0.164KG/M

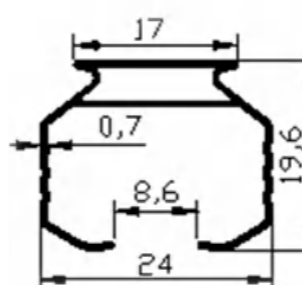

CS26

We have stable raw material purchasing line, we keep the superior granddraw material to keep high quality.

LANTERN NANO TRACK
MATTE WHITE

—
LENGTH: 6.7/6.0M/PIECE
WEIGHT: 0.122KG/M

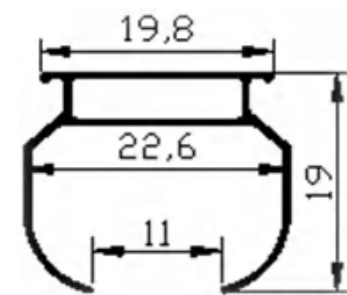

CS28



● Bright rose gold

● Matte white

22+20 ONE LINE NANO TRACK

PARAMETER

—
LENGTH: 6.7/6.0M/PCS

WEIGHT: 0.126KG/M



CS29



16+20 ONE LINE NANO TRACK

—
 LENGTH: 6.7/6.0M/PCS
 WEIGHT: 0.105KG/M

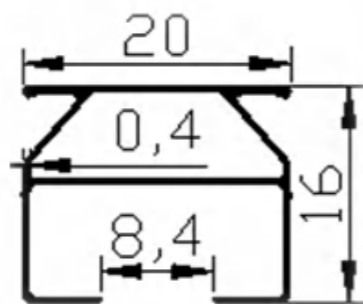

CS44

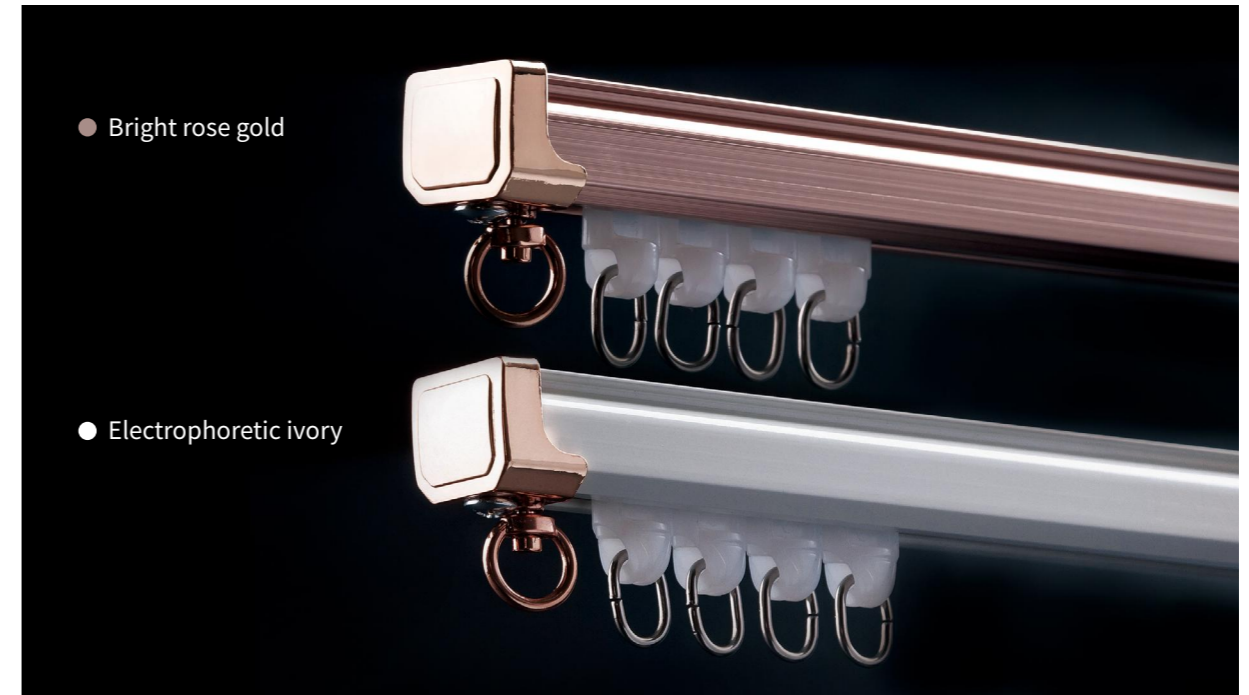

EXTRA THICK SMALL SQUARE TRACK B-TYPE

—
 LENGTH: 6.7/6.0M/PIECE
 WEIGHT: 0.201KG/M

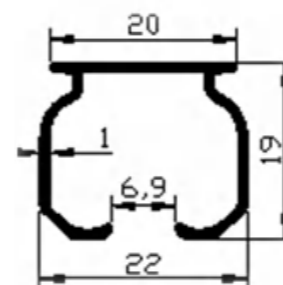

CS47



THICKENED MEDIUM SQUARE

TRACK B-TYPE

LENGTH: 6.7/6.0M/PCS

WEIGHT: 0.26KG/M

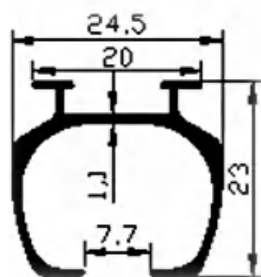

CS65

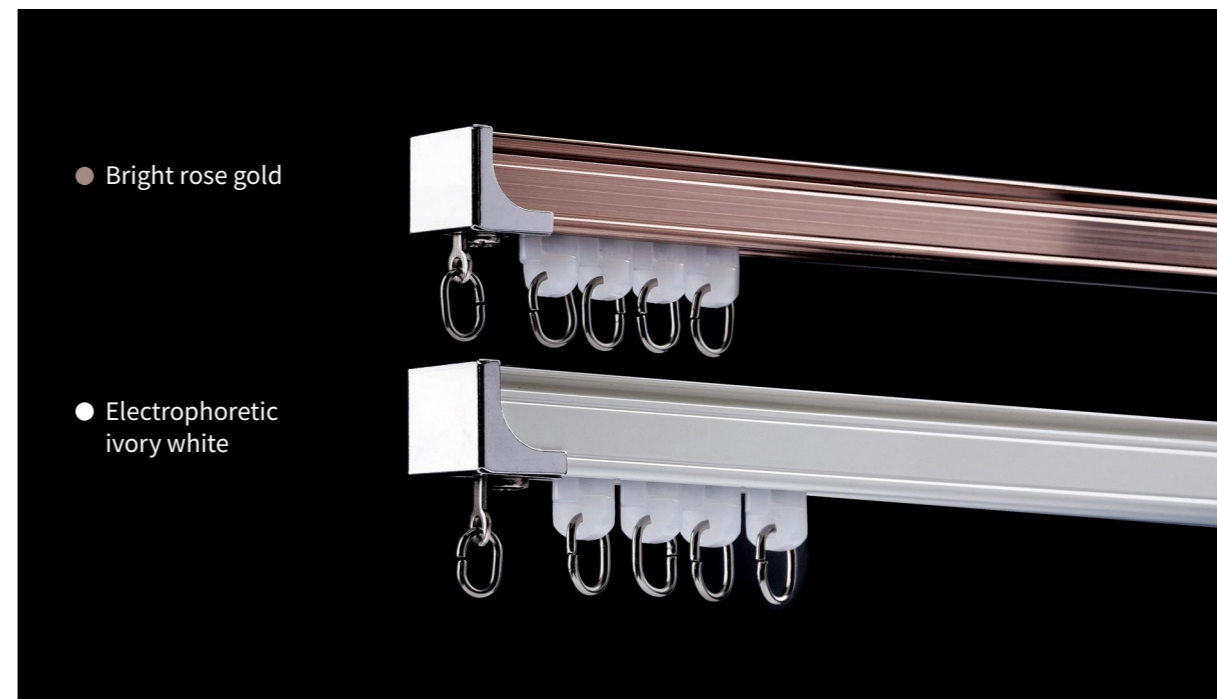

T20+20 THICKENED TWO-LINE

SMALL SQUARE TRACK

LENGTH: 6.7/6.0M/PIECE

WEIGHT: 0.202KG/M

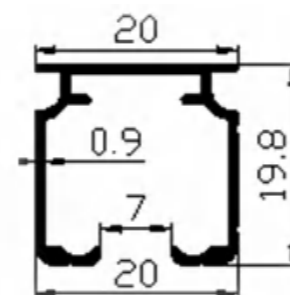

CS76

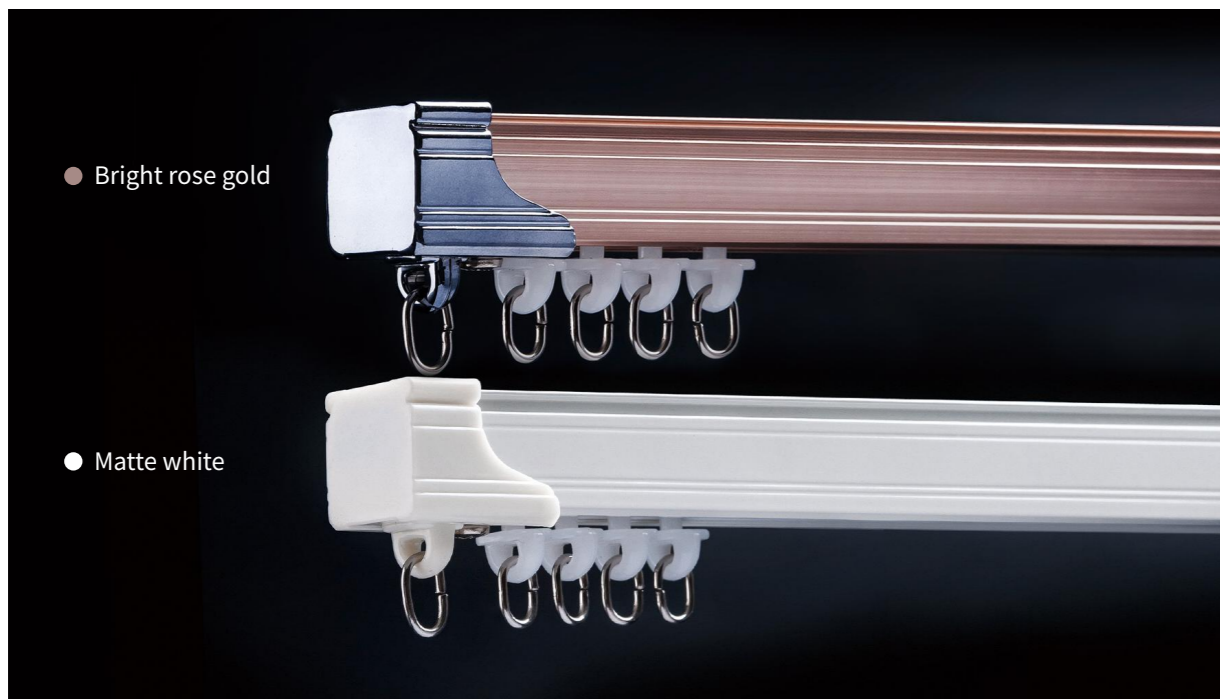

23+20 INTERCOM WIRE NANOSCALE

MEDIUM SQUARE TRACK

LENGTH: 6.7/6.0M/PCS

WEIGHT: 0.163KG/M

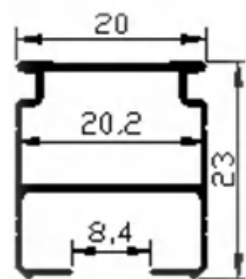

M02



THICKENED MEDIUM

SQUARE TRACK

LENGTH: 6.7/6.0M/PIECE

WEIGHT: 0.318KG/M

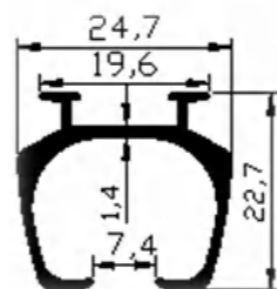

M88

LIGHT LUXURY D+5
 LARGE SQUARE TRACK
 —
 LENGTH: 6.7/6.0M/PCS
 WEIGHT: 0.304KG/M
 THICKNESS: 1.0MM

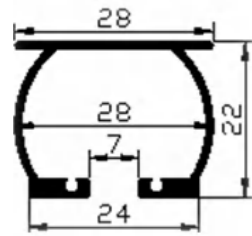

V5



Three specifications to suit different needs

Brushed texture, strong modern craft. National standard aluminum, strong load-bearing capacity

Silent configuration, smooth and smooth. Moisture-proof and heat-resistant, long-lasting shine

BRIGHT BRUSHED GOLD

BRUSHED IRON GRAY

LIGHT BRUSHED BLACK

V5 LARGE SQUARE TRACK

V5 LARGE SQUARE TRACK

LENGTH: 6.7/6.0M/PCS
WEIGHT: 0.266KG/M
THICKNESS: 1.0MM

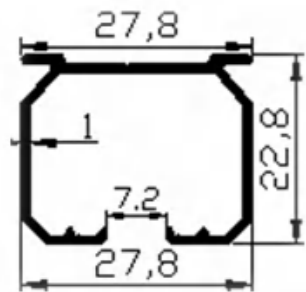

○ Brushed iron gray



● Bright brushed gold



● Light brushed black



○ Electrophoretic ivory white

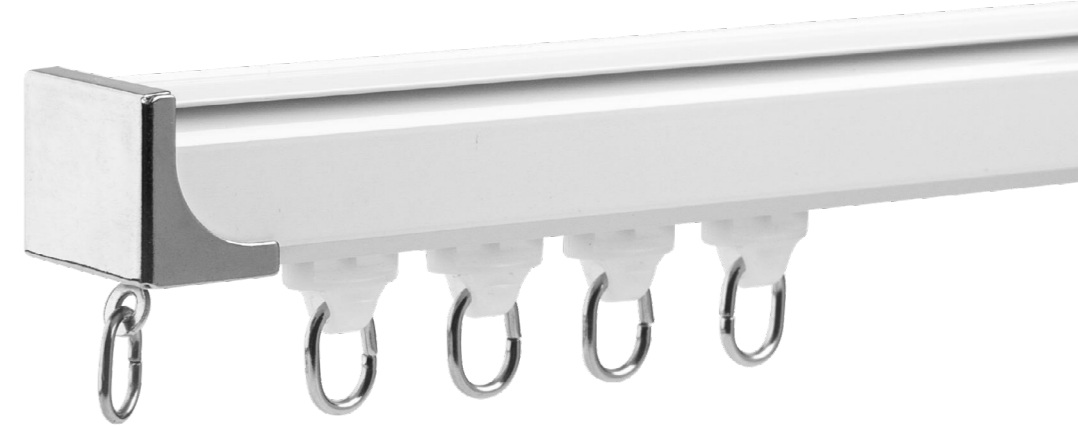

● Porcelain swimming light gray



V5 LARGE SQUARE TRACK

LENGTH: 6.7/6.0M/PCS
WEIGHT: 0.266KG/M
THICKNESS: 1.0MM

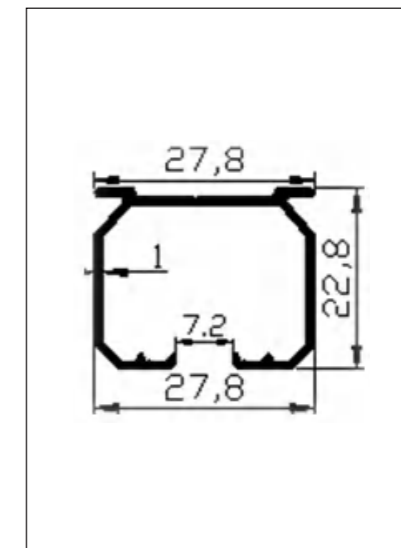

V5 MEDIUM SQUARE TRACK

V5 MEDIUM SQUARE TRACK

LENGTH: 6.7/6.0M/PCS

WEIGHT: 0.18KG/M

THICKNESS: 0.65MM

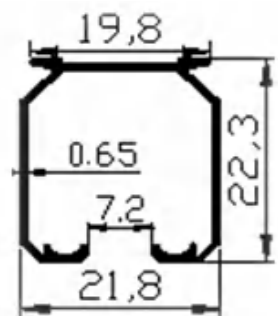

○ Brushed iron gray



● Bright brushed gold



● Light brushed black



○ Electrophoretic ivory white



● Porcelain swimming light gray



V5 MEDIUM SQUARE TRACK

LENGTH: 6.7/6.0M/PCS

WEIGHT: 0.18KG/M

THICKNESS: 0.65MM

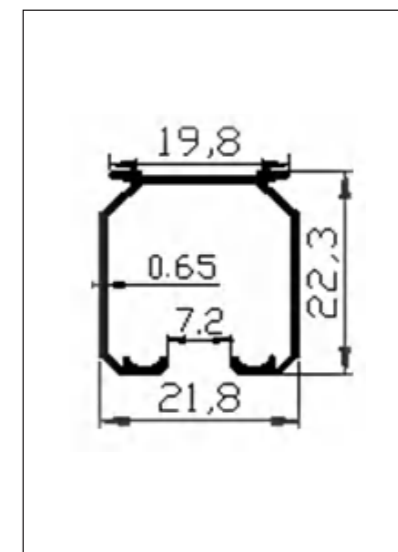

V5 SMALL SQUARE TRACK

V5 SMALL SQUARE TRACK

LENGTH: 6.7/6.0M/PCS
WEIGHT: 0.157KG/M
THICKNESS: 0.65MM

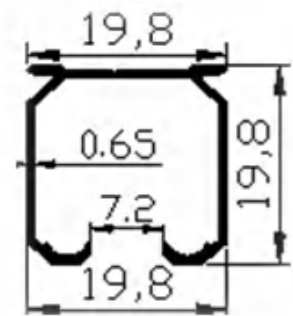

○ Brushed iron gray



● Bright brushed gold



● Light brushed black



○ Electrophoretic ivory white



● Porcelain swimming light gray



V5 SMALL SQUARE TRACK

LENGTH: 6.7/6.0M/PCS
WEIGHT: 0.157KG/M
THICKNESS: 0.65MM

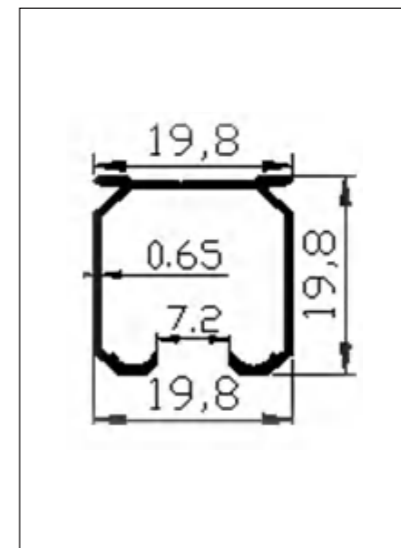

V6



- SUPERB ELECTROPHORESIS/
PORCELAIN SWIMMING

- PREFERRED ALUMINUM
U-SHAPED SLOT GUIDE

- SIMPLE ALLOY SEAL
LOAD-BEARING MOUNTING CODE



- CAMBER GRADIENT
VISUAL PERCEPTION

- SUPER LIGHT
SLIPPERY
NANO BLACK WHEEL

- SUPER LIGHT
RUNNER

V6 series square rail, minimalist elegant appearance, suitable for the home with attitude

V6 LARGE SQUARE TRACK

○ Electrophoretic ivory white



● Porcelain swimming light gray



V6 LARGE SQUARE TRACK

PARAMETER

LENGTH: 6.7/6.0M/PIECE

WEIGHT: 0.266KG/M

THICKNESS: 0.9MM

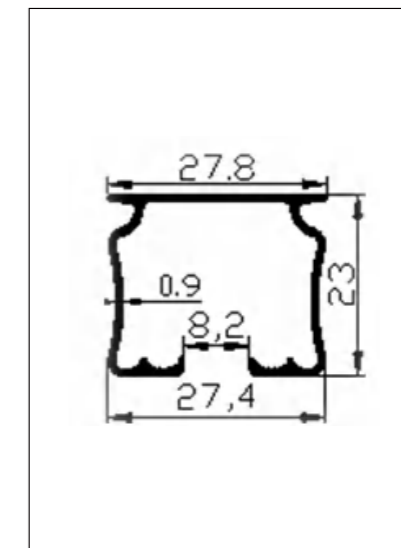

V6 MEDIUM SQUARE TRACK

○ Electrophoretic ivory white



● Porcelain swimming light gray



V6 LARGE SQUARE TRACK

PARAMETER

LENGTH: 6.7/6.0M/PIECE

WEIGHT: 0.266KG/M

THICKNESS: 0.8MM

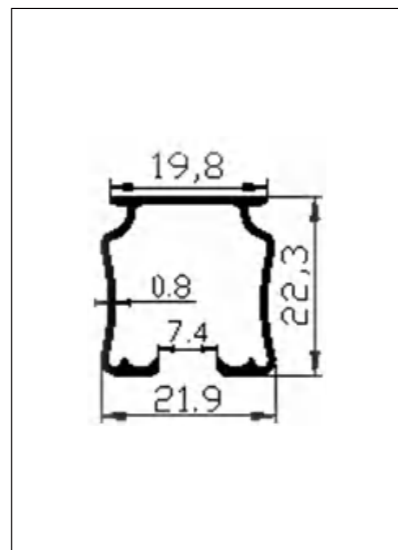

V6 SMALL SQUARE TRACK

○ Electrophoretic ivory white



● Porcelain swimming light gray



V6 LARGE SQUARE TRACK

PARAMETER

LENGTH: 6.7/6.0M/PIECE

WEIGHT: 0.153KG/M

THICKNESS: 0.6MM

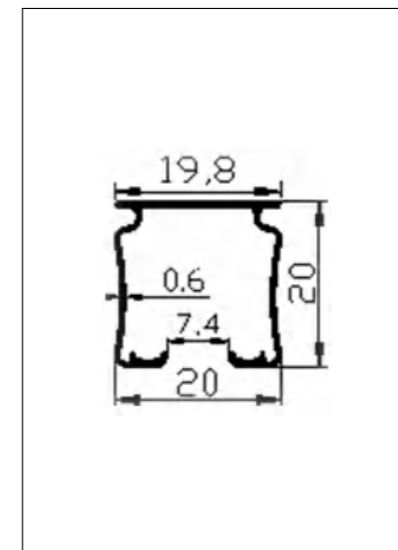



- ULTRA-THIN DESIGN FOR NARROW SPACES
- INTERNAL WINDOW/REVERSE WINDOW IS RECOMMENDED
- NATIONAL STANDARD ALUMINUM HAS STRONG LOAD-BEARING CAPACITY
- SMOOTH AND WEAR-RESISTANT SILENT WHEEL

WR271

Surface electrophoresis process,
moisture and heat resistance, lasting shine

ULTRA-THIN STRAIGHT TRACK
PARAMETER

LENGTH: 6.7/6.0M/PIECE
WEIGHT: 0.137KG/M

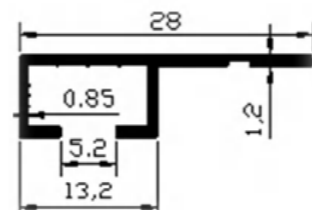

WR341

We have stable raw material purchasing line, we keep the superior granddraw material to keep high quality.

21+22 NANOMETER
MEDIUM SQUARE TRACK
—
LENGTH: 6.7/6.0M/PIECE
WEIGHT: 0.116KG/M

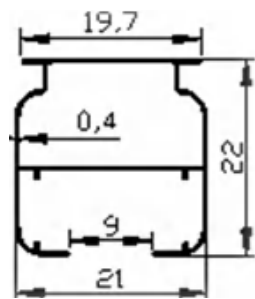

WR476

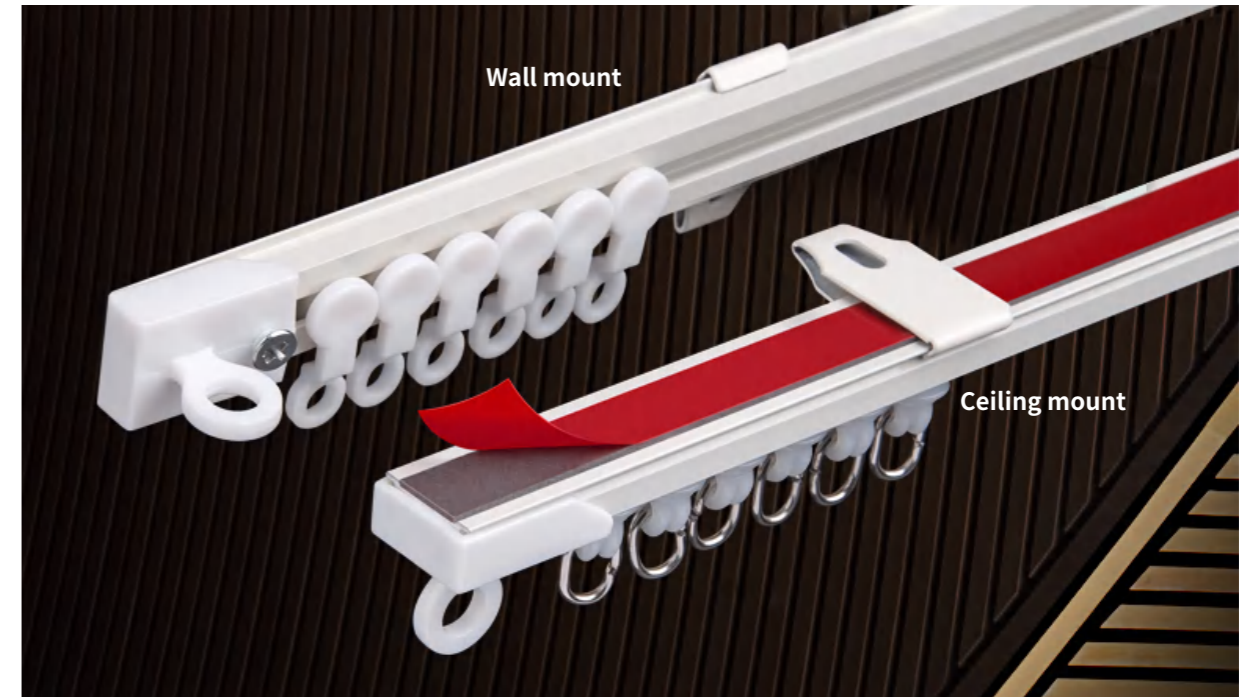

PUNCH-FREE AND CARD CODE

SELF-ADHESIVE TRACK

—
LENGTH: 6.7/6.0M/PIECE

WEIGHT: 0.134KG/M

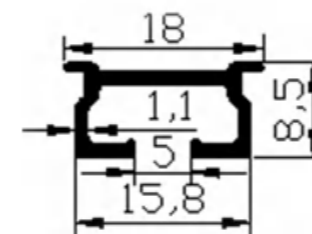

02 BENDABLE & STRAIGHT TRACK SERIE



Space partition super expert, open space seconds become independent space.

Curved and straight aluminum profiles. More functional, better environmental adaptability.

Boom length can be customized.

HOT SALE

WR302



CLASSIC BLACK AND WHITE

COLORS AVAILABLE

LENGTH: 6.7/6.0M/PCS

WEIGHT: 0.067KG/M

THICKNESS: 0.8MM

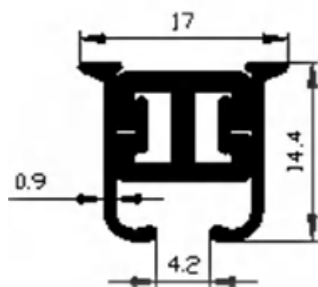

WR303



WR303 BENDABLE &

STRAIGHT TRACK

LENGTH: 6.7/6.0M/PIECE

WEIGHT: 0.112KG/M

THICKNESS: 1.0MM

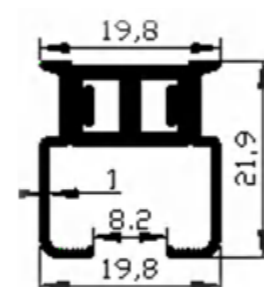



Internal and external mounting
Dual use of bending and straightening

WR375



BENDABLE & STRAIGHT TRACK

WITH OUTER EDGE

LENGTH: 6.7/6.0M/PIECE

WEIGHT: 0.121KG/M

THICKNESS: 1.0MM

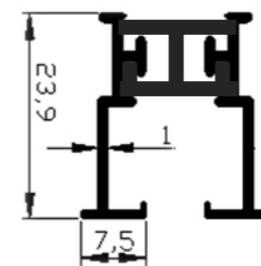

03 CURVED TRACK SERIES



HIGH QUALITY STEEL AND ALUMINUM, STRONG PLASTICITY
 MUTE CONFIGURATION, SO THAT THE CURTAIN IS MORE SMOOTH AND SMOOTH

HOT SALE

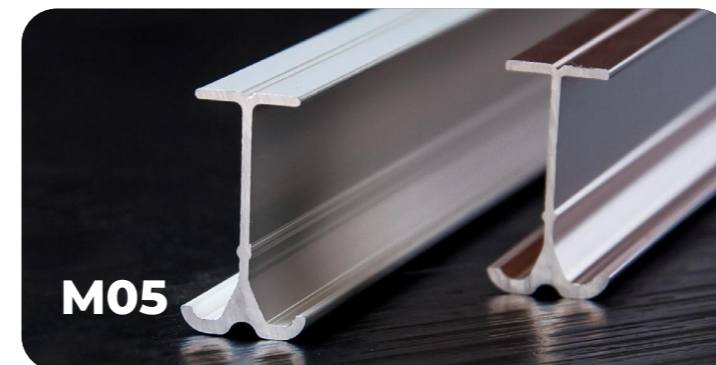

B87

○ Electrophoretic porcelain white

● Porcelain swimming light gray

● Curry blue



BEAUTIFUL W-3 NM
MID-BEND TRACK

—
LENGTH: 6.7/6.0M/PCS
WEIGHT: 0.182KG/M
THICKNESS: 0.9MM

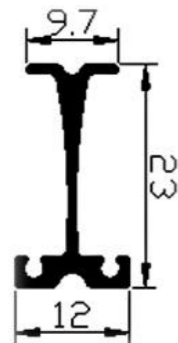

M05



ONE LINE CENTER BEND TRACK

PARAMETER

—
LENGTH: 6.7/6.0M/PCS

WEIGHT: 0.105KG/M

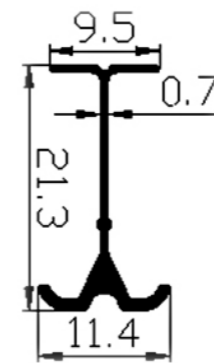



M24

CURTAIN HEAD TRACK SERIES

ORDINARY CURTAIN TRACK
WEIGHT:0.12KG/M

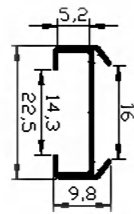

M24-04



M24-08 generous track magnetic collision

SEVEN-FIGURE MAGIC TRACK A
WEIGHT:0.135KG/M

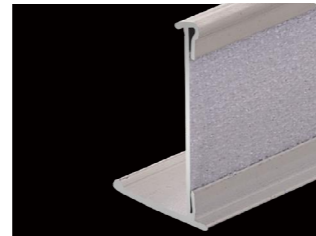
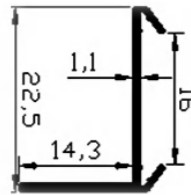

M24-05



M24-09 medium square track magnetic collision

ONE-WORD MAGIC TRACK
WEIGHT:0.109KG/M

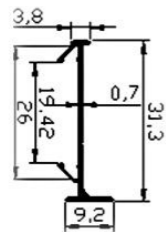

M24-06



M24-10 medium bend track magnetic collision

WP-G5

THREE-WIRE
MID-BEND TRACK

LENGTH: 6.7/6.0M/PCS
WEIGHT: 0.141KG/M
THICKNESS: 0.9MM

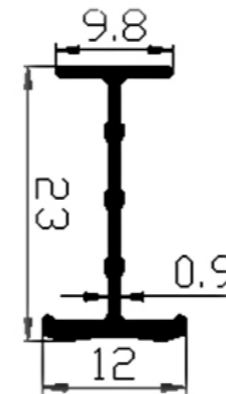

If you want to know more about the product, you can visit the website above, or consult our customer service

IN STOCK

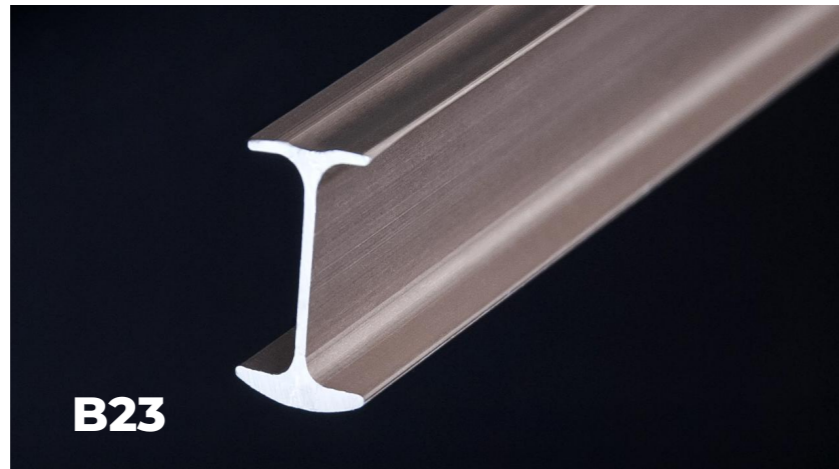

CS100



INSIDE WINDOW SMALL CURVED TRACK

PARAMETER

LENGTH: 6.7/6.0M/PCS

WEIGHT: 0.078KG/M

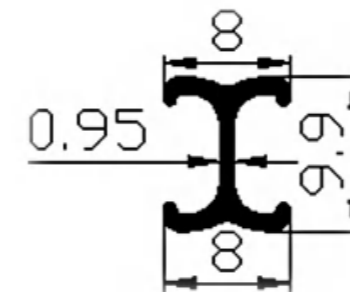

B23

● B23-01 Matte Apple gold



○ B23-02 Electrophoretic Ivory



HEAVY DUTY MEDIUM CURVED TRACK

PARAMETER

—
LENGTH: 6.7/6.0M/PIECE

WEIGHT: 0.133KG/M

THICKNESS: 0.8MM

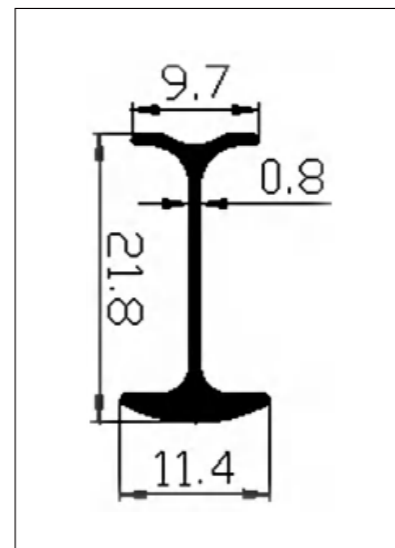

Alloy wheel



Plastic wheel

B32

○ B32-01 Ivory white



○ B32-02 Ivory white



DISCOUNT / U-SHAPED

MEDIUM CURVED TRACK

—
LENGTH: 6.7/6.0M/PIECE

WEIGHT: 0.104KG/M

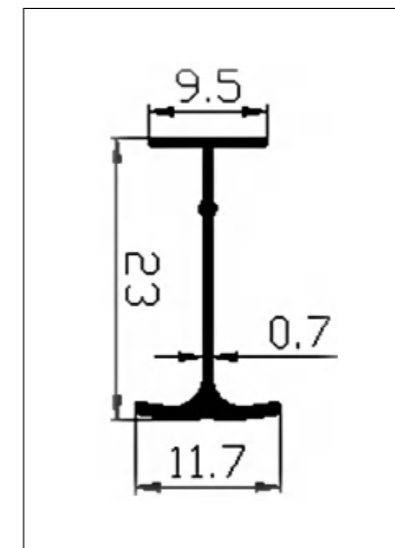

Alloy wheel

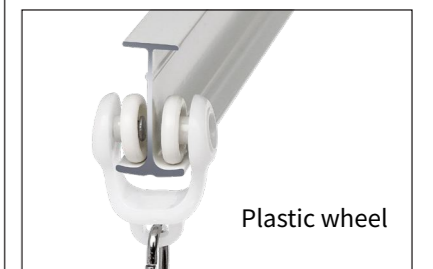

Plastic wheel

CUSTOMIZATION



B08

○ B08-02 Electrophoresis ivory white

● B08-03 Oxidized matte apple gold

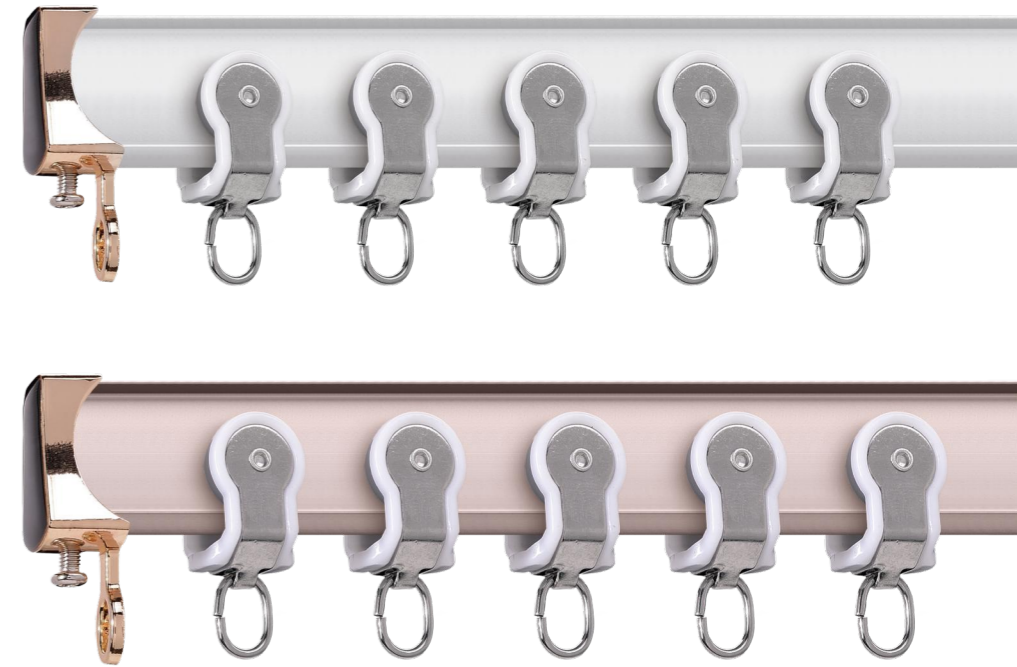

HEAVY DUTY BIG CURVED TRACK

LENGTH: 6.7/6.0M/PCS

WEIGHT: 0.233KG/M

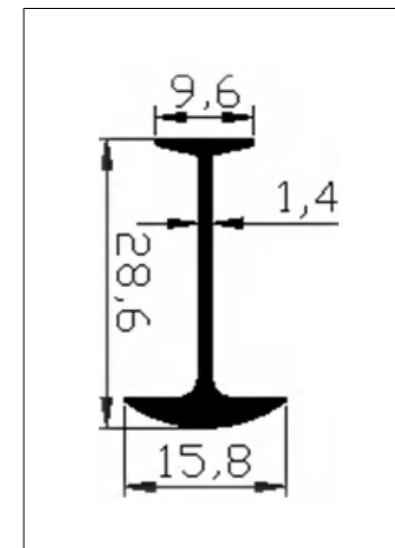

B10

● B10-01 Oxidized matte Champagne



○ B10-02 Electrophoretic Ivory white



● B10-06 Crystal Swim Champagne



NEW ERA CURVED TRACK SERIES

LENGTH: 6.7/6.0M/PCS

WEIGHT: 0.126KG/M

THICKNESS: 0.9MM

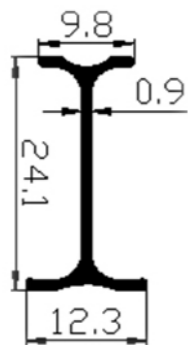

Stainless steel wheel



Plastic wheel

B57

THE NANO-MEDIUM CURVED TRACK WITH NANO MUTE STRIP

LENGTH: 6.7/6.0M/PCS

WEIGHT: 0.177KG/M

THICKNESS: 0.9M

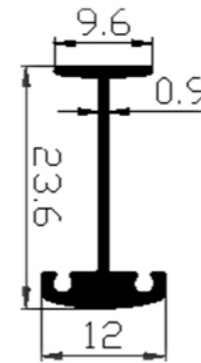

● B57-01 Ivory white



● B57-02 Ivory white



● B57-03 Matte Apple Gold



● B57-04 Matte Apple Gold



B68

○ B68-01 Electrophoretic ivory white

● B68-02 Matte apple gold



EXCELLENT MEDIUM CURVED TRACK

LENGTH: 6.7/6.0M/PCS

WEIGHT: 0.136KG/M

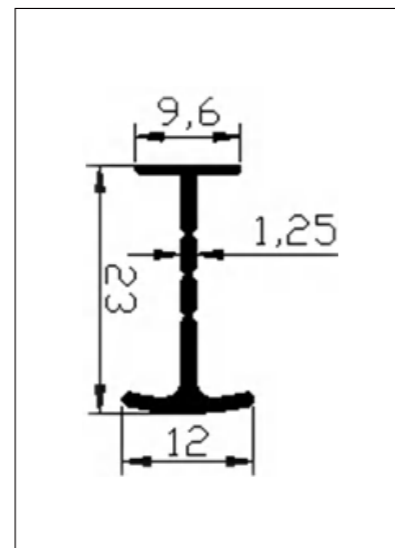

CS126

● Bright rose gold

● Matte white



FASHION MEDIUM CURVED TRACK

LENGTH: 6.7/6.0M/PCS

WEIGHT: 0.144KG/M

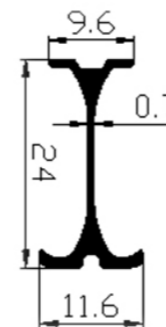

CS190



THICKENED TIME CENTER

CURVED TRACK

LENGTH: 6.7/6.0M/PCS

WEIGHT: 0.224KG/M

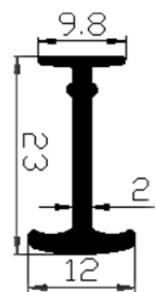

M19



CLASSIC BIG CURVED TRACK

LENGTH: 6.7/6.0M/PCS

WEIGHT: 0.188KG/M

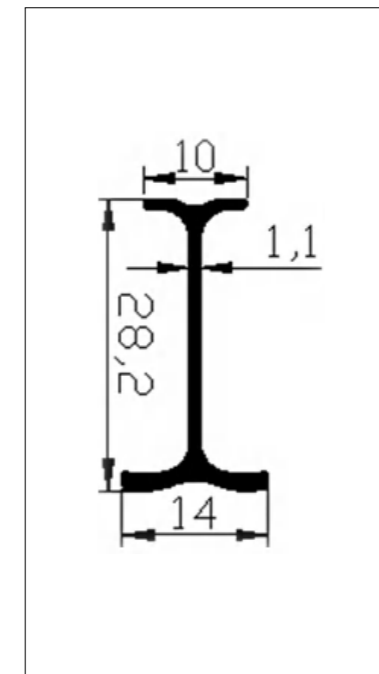

M72



PRISMATIC MID- CURVED TRACK

PARAMETER

LENGTH: 6.7/6.0M/PCS

WEIGHT: 0.137KG/M



M90



LIGHT LUXURY D+7 NM MEDIUM

CURVED TRACK

LENGTH: 6.7/6.0M/PCS

WEIGHT: 0.166KG/M

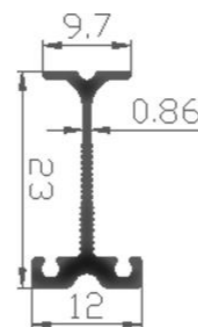

WR113



ELEGANT SILENT A-3 MID-CURVED TRACK

LENGTH: 6.7/6.0M/PCS

WEIGHT: 0.22KG/M

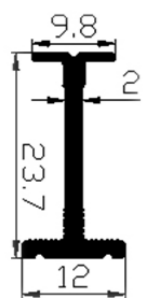

WR141



FASHION D3+ CENTER CURVED TRACK

LENGTH: 6.7/6.0M/PCS

WEIGHT: 0.234KG/M

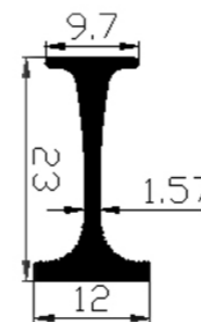

WR145



SIMPLE Y-3 MID-CURVED TRACK

LENGTH: 6.7/6.0M/PCS

WEIGHT: 0.199KG/M

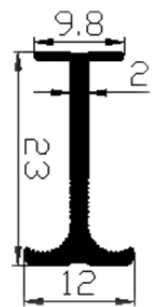

WR189



ALTAI T6 MID- CURVED TRACK

LENGTH: 6.7/6.0M/PCS

WEIGHT: 0.176KG/M

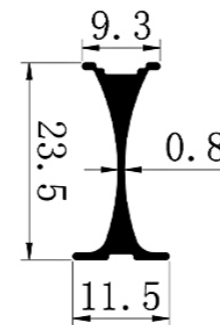

WR329

V5 MID-CURVED TRACK

LENGTH: 6.7/6.0M/PCS

WEIGHT: 0.137KG/M

THICKNESS: 0.8MM

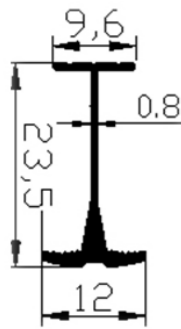

○ Electrophoretic ivory white

● Porcelain swimming light gray

● Bright brushed gold

● Brushed iron gray

● Light brushed black



WR451



WR451 NM MID-CURVED TRACK

LENGTH: 6.7/6.0M/PCS

WEIGHT: 0.102KG/M

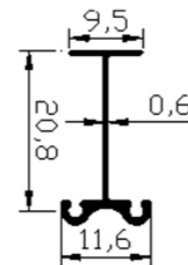

WR452



WR452 MID-CURVED TRACK

LENGTH: 6.7/6.0M/PCS

WEIGHT: 0.099KG/M

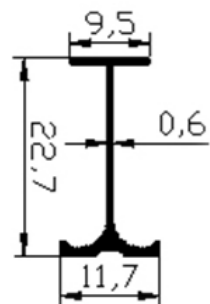

WR462



WR462 MID-CURVED TRACK

LENGTH: 6.7/6.0M/PCS

WEIGHT: 0.096KG/M

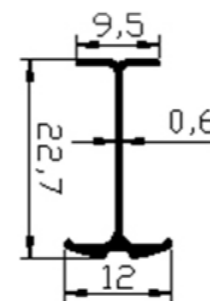

04 SILENT TRACK SERIES



HIGH QUALITY STEEL AND ALUMINUM, STRONG PLASTICITY
MUTE CONFIGURATION, SO THAT THE CURTAIN IS MORE SMOOTH AND SMOOTH

IN STOCK



WR439

WR439 THICKENED NANO SQUARE TRACK

PARAMETER

LENGTH: 6.7/6.0M/PCS

WEIGHT: 0.297KG/M

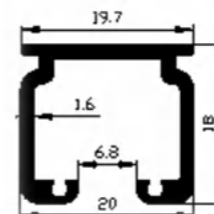

CUSTOMIZATION



PVC MUTE STRAIGHT TRACK



IT IS QUIET AND SMOOTH

PARAMETER

LENGTH: 6.7/6.0M/PCS

THICKNESS: 1.5MM

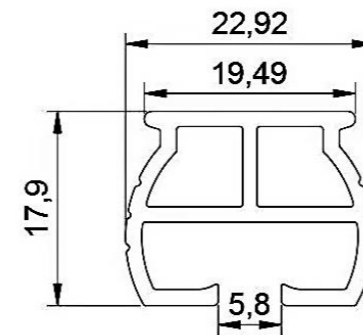

WR450



BUILT-IN MUTE BAR CAN BE USED ON DEMAND

LENGTH: 6.7/6.0M/PCS

WEIGHT: 0.129KG/M

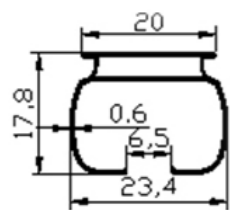

WR454



BUILT-IN MUTE BAR CAN BE USED ON DEMAND

LENGTH: 6.7/6.0M/PCS

WEIGHT: 0.186KG/M

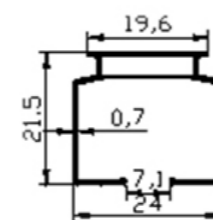

WR455



BUILT-IN MUTE BAR CAN BE
USED ON DEMAND

LENGTH: 6.7/6.0M/PCS

WEIGHT: 0.161KG/M

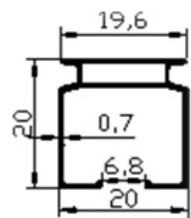

WR456



BUILT-IN MUTE BAR CAN BE
USED ON DEMAND

LENGTH: 6.7/6.0M/PCS

WEIGHT: 0.159KG/M

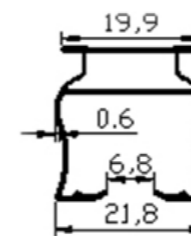

WR457



BUILT-IN MUTE BAR CAN BE
USED ON DEMAND

LENGTH: 6.7/6.0M/PCS

WEIGHT: 0.163KG/M

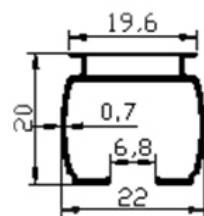

WR458



BUILT-IN MUTE BAR CAN BE
USED ON DEMAND

LENGTH: 6.7/6.0M/PCS

WEIGHT: 0.145KG/M

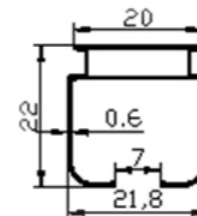

WR460



BUILT-IN MUTE BAR CAN BE USED ON DEMAND

LENGTH: 6.7/6.0M/PCS

WEIGHT: 0.197KG/M

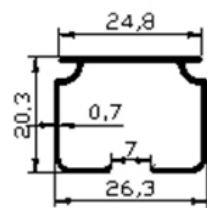

WR461



BUILT-IN MUTE BAR CAN BE USED ON DEMAND

LENGTH: 6.7/6.0M/PCS

WEIGHT: 0.135KG/M

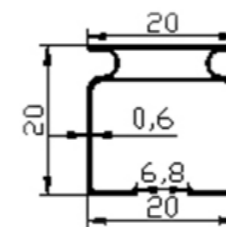

WR466



BUILT-IN MUTE BAR CAN BE USED ON DEMAND

LENGTH: 6.7/6.0M/PCS

WEIGHT: 0.161KG/M

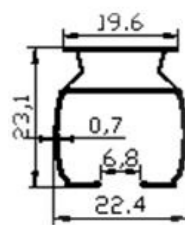

WR467



BUILT-IN MUTE BAR CAN BE USED ON DEMAND

LENGTH: 6.7/6.0M/PCS

WEIGHT: 0.141KG/M

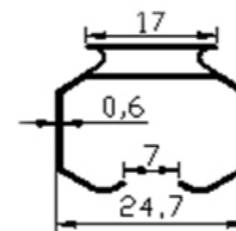

WR468



● ivory white

BUILT-IN MUTE BAR CAN BE
USED ON DEMAND

LENGTH: 6.7/6.0M/PCS

WEIGHT: 0.141KG/M

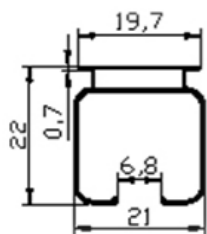

WR469



● ivory white

BUILT-IN MUTE BAR CAN BE
USED ON DEMAND

LENGTH: 6.7/6.0M/PCS

WEIGHT: 0.157KG/M

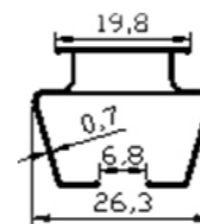

WR470



BUILT-IN MUTE BAR CAN BE USED ON DEMAND

PARAMETER

LENGTH: 6.7/6.0M/PCS

WEIGHT: 0.119KG/M

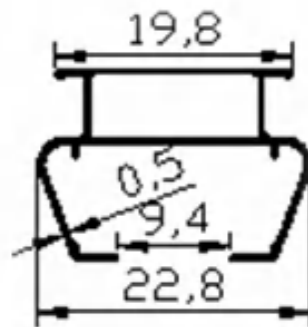

WR444



GLIDE SILENT STRAIGHT TRACK

BUILT-IN MUTE BAR CAN BE USED ON DEMAND

PARAMETER

LENGTH: 6.7/6.0M/PCS

WEIGHT: 0.119KG/M

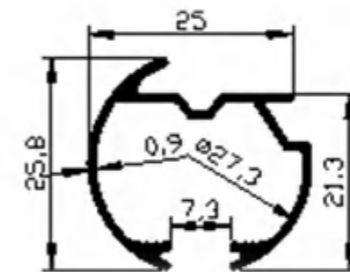

WR490



GLIDE SILENT STRAIGHT TRACK

BUILT-IN MUTE BAR CAN BE USED ON DEMAND

PARAMETER

LENGTH: 6.7/6.0M/PCS

WEIGHT: 0.255KG/M



WR491



GLIDE SILENT STRAIGHT TRACK

BUILT-IN MUTE BAR CAN BE USED ON DEMAND

PARAMETER

LENGTH: 6.7/6.0M/PCS

WEIGHT: 0.289KG/M

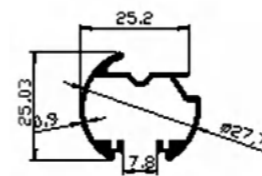

05 DOUBLE TRACK SERIES



THE DOUBLE SLOT DESIGN GUIDES THE CURTAIN TO OVERLAP THE DEPTH OF SHADING, AND THE SIZE OF THE CURTAIN OVERLAP AREA IS UNLIMITED

IN STOCK



WR342

SMALL DOUBLE GROOVED TRACK

PARAMETER

LENGTH: 6.7/6.0M/PCS

WEIGHT: 0.24KG/M

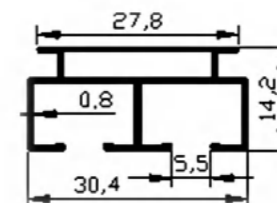

IN STOCK



WR343

LARGE DOUBLE GROOVED TRACK

PARAMETER

LENGTH: 6.7/6.0M/PCS

WEIGHT: 0.286KG/M

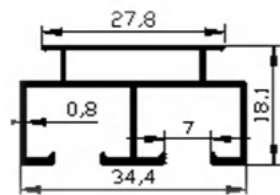

If you want to know more about the product, you can visit the website above, or consult our customer service

CUSTOMIZATION

WR366 NANO DOUBLE TRACK



- BUILT-IN MUTE BAR SMOOTH MUTE
- SIMPLE DESIGN OF CONNECTED ORBIT
- SURFACE ELECTROPHORESIS PROCESS LASTING SHINE

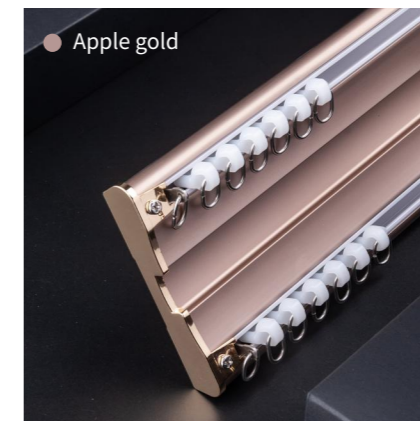
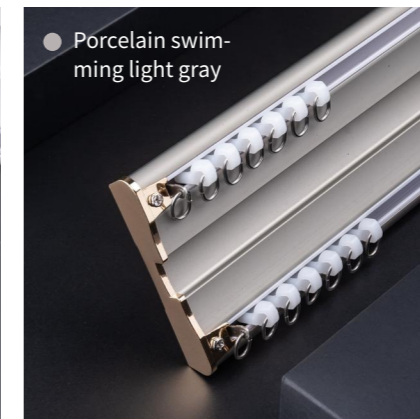
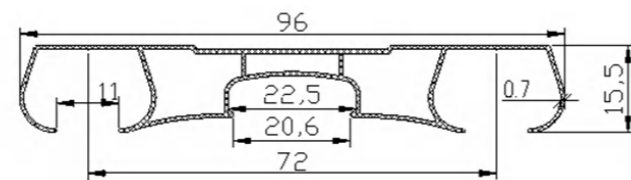

PARAMETER

LENGTH: 6.7/6.0/M/PCS

WEIGHT: 0.483KG/M

WR60



THE DOUBLE TRACK OF THE NEW ERA

LENGTH: 6.7/6.0M/PCS

WEIGHT: 0.939KG/M

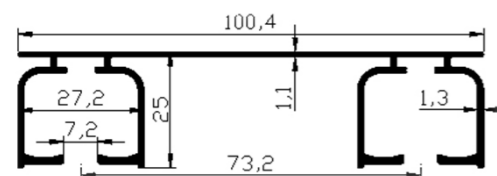

WR60 (SILENT MODEL)



THE DOUBLE TRACK OF THE NEW ERA

LENGTH: 6.7/6.0M/PCS

WEIGHT: 0.939KG/M

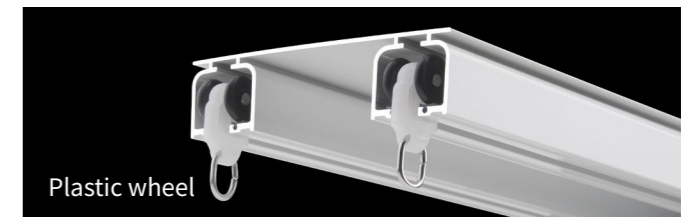
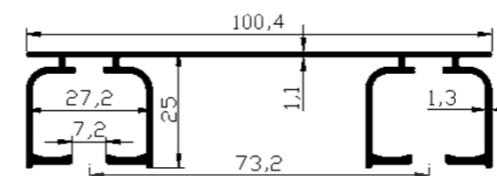

06 EMBEDDED TRACK SERIES



CUSTOMIZATION



- BUILT-IN WALL •
- NATIONAL STANDARD ALUMINUM, STRONG BEARING CAPACITY •
- SMOOTH AND WEAR-RESISTANT SILENT WHEEL •

WR312



EMBEDDED OUTER EDGE SQUARE TRACK

LENGTH: 6.7/6.0M/PCS

WEIGHT: 0.198KG/M

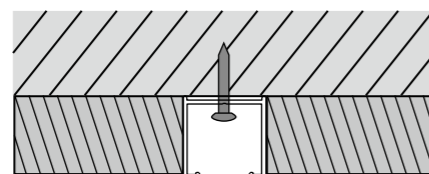
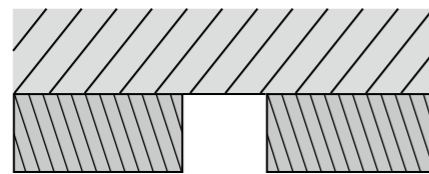
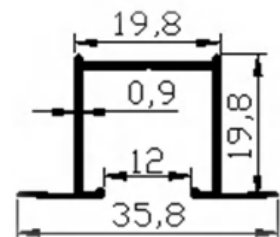

WR335



EMBEDDED PRE INSTALLED TRACK

LENGTH: 6.7/6.0M/PCS

WEIGHT: 0.297KG/M

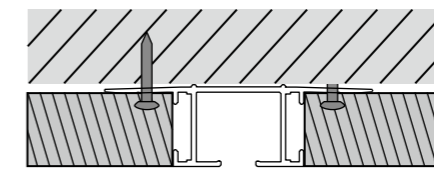
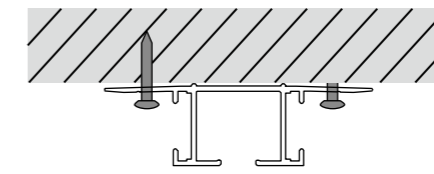
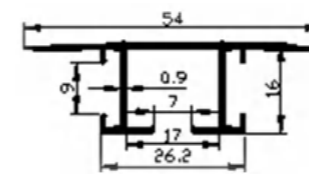

WR385



IN STOCK

LARGE EMBEDDED BENDABLE & STRAIGHT TRACK

LENGTH: 6.7/6.0M/PCS

WEIGHT: 0.24KG/M

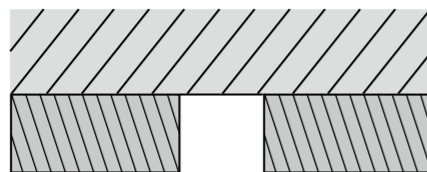
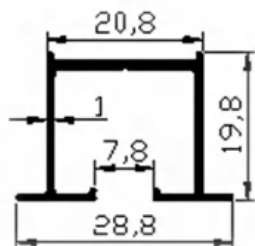

01. Wall/board grooving

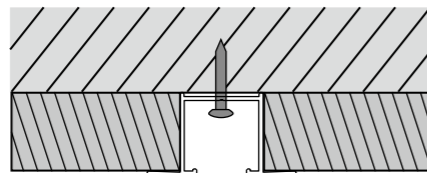

02. Load the profile and fix it



WR406



IN STOCK

SMALL EMBEDDED STRAIGHT TRACK

LENGTH: 6.7/6.0M/PCS

WEIGHT: 0.145KG/M

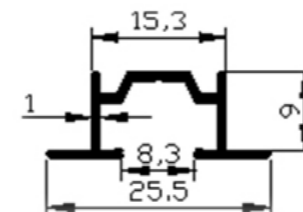

07 THREE IN ONE CURTAIN BOX SERIES

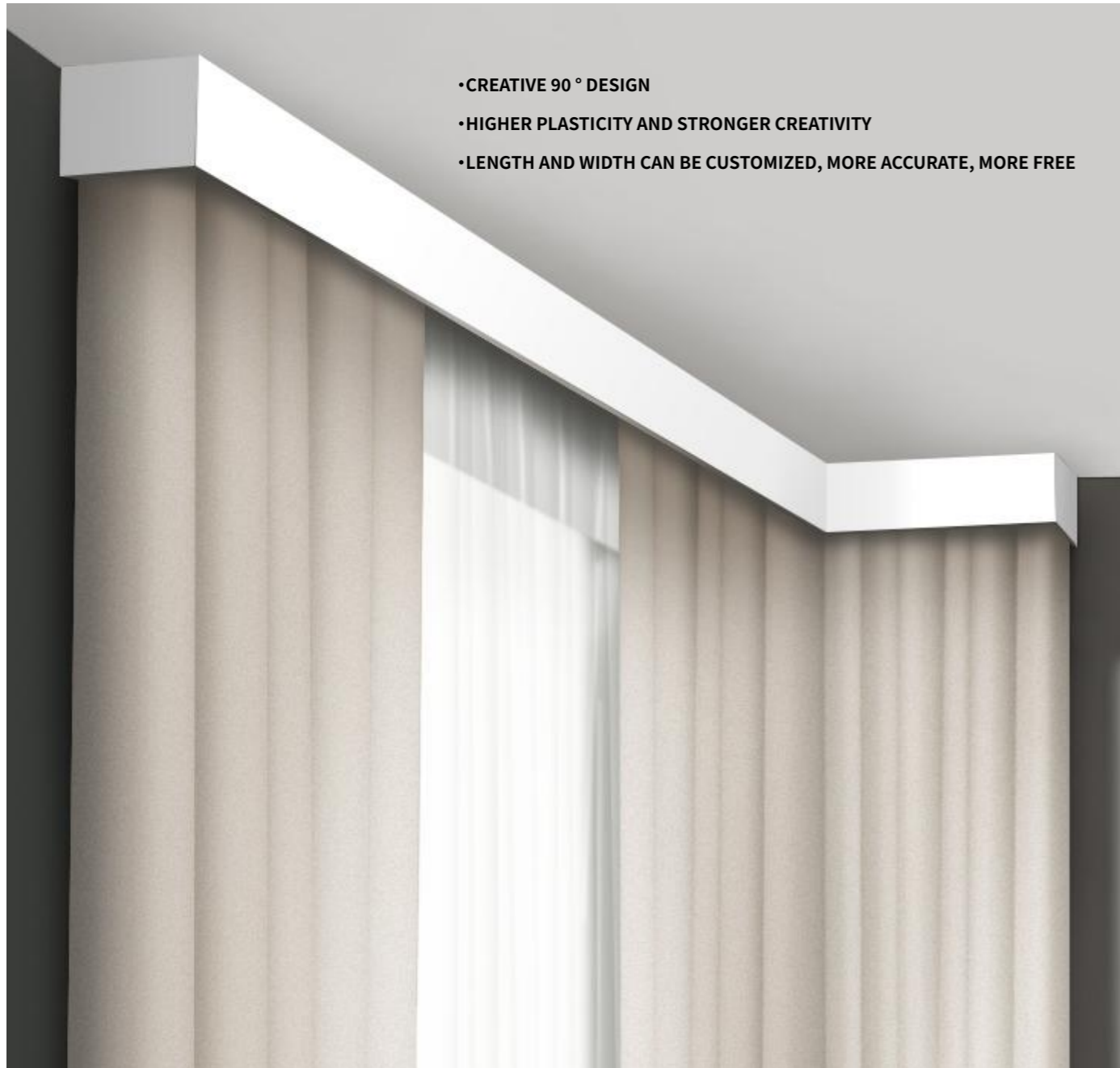

- CREATIVE 90 ° DESIGN
- HIGHER PLASTICITY AND STRONGER CREATIVITY
- LENGTH AND WIDTH CAN BE CUSTOMIZED, MORE ACCURATE, MORE FREE

CURTAIN BOX BAFFLE



Single track + curtain box baffle



Double track + curtain box baffle



Connected track + curtain box baffle



SMALL EMBEDDED STRAIGHT TRACK

LENGTH: 6.7/6.0M/PCS

WEIGHT: 0.615KG/M

